

**Welcome**

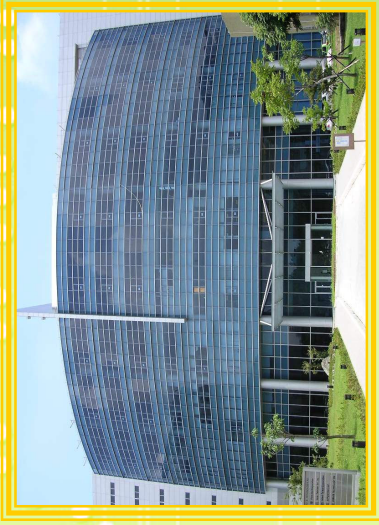

*Welcome*

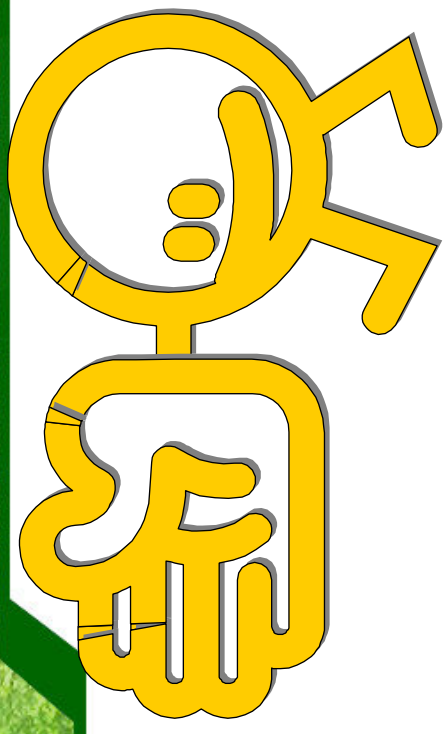

# YoungTek Electronics Corp.

Stock No: 6261

## Brief Introduction

Spokesman : Tony Liu  
Date : 14 February, 2012



YoungTek Electronics Corp.



# 2012 VISIT SCHEDULE @久元

Company Profile

## Contents

## Time

- |   |             |
|---|-------------|
| <input type="checkbox"/> Brief Introduction of YTEC | 14:00~14:20 |
| <input type="checkbox"/> Q & A                      | 14:20~15:30 |
| <input type="checkbox"/> Line Tour (Free)           | 15:30~16:00 |



**YTEC** YoungTek Electronics Corp.

# Contents

*Company Profile*

- **Brief Introduction**
- **Factory Overview**
- **Company Milestone**
- **Company Management Concept**
- **OEM Services**
- **R&D Roadmap and Own Product Development**
- **Revenue Growth**
- **Company Mission**



**YoungTek Electronics Corp.**



# Brief Introduction

## Company Profile

**Found Time** : 1991/July

**Chairman** : Bily Wang

**President of Service Group** : Jeff Chang

**President of Own Product Group** : Glen Chen

**Employees** : 993

**Capital** : NTD 1065 million (USD 35.5 million)

**Address** : Plant 1(1F~5F) : Special & substrate sawing

An Ping Plant (3F) : LED sorting & testing

Li Hsin Plant (2~3F、5~6F) : LED back-end turn-key service

SBIP Plant (1~4F、7F) : IC back-end turn-key service, ATE&AOI

### **Business Items** :

- Semiconductor and LED OEMs**: Wafer sawing, grinding, sorting and IC testing, LED testing, laser scribing, sorting and substrate sawing.
- Design, manufacture and sales of semiconductor equipments**: CIS/CCM equipments, AOI system, full-function IC tester, logic IC tester, analog IC tester, Mixed-Signal IC Tester, **LED** tester, prober and sorter.

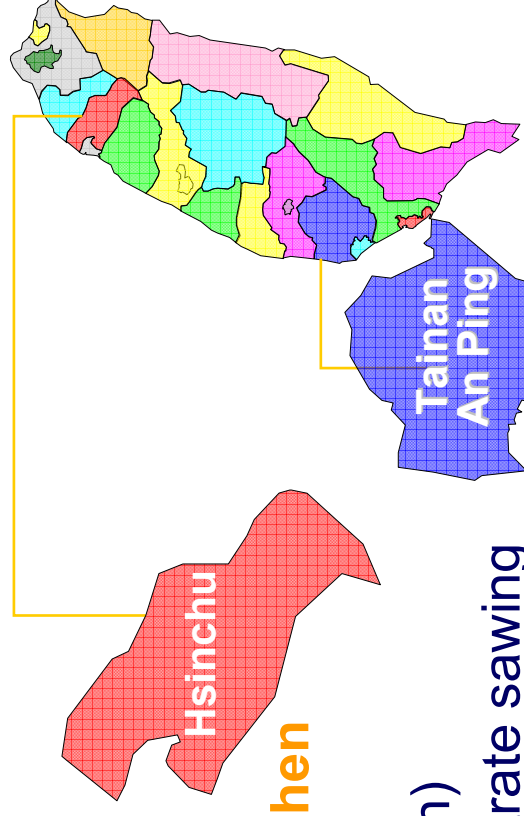

# Factory Overview

Company Profile

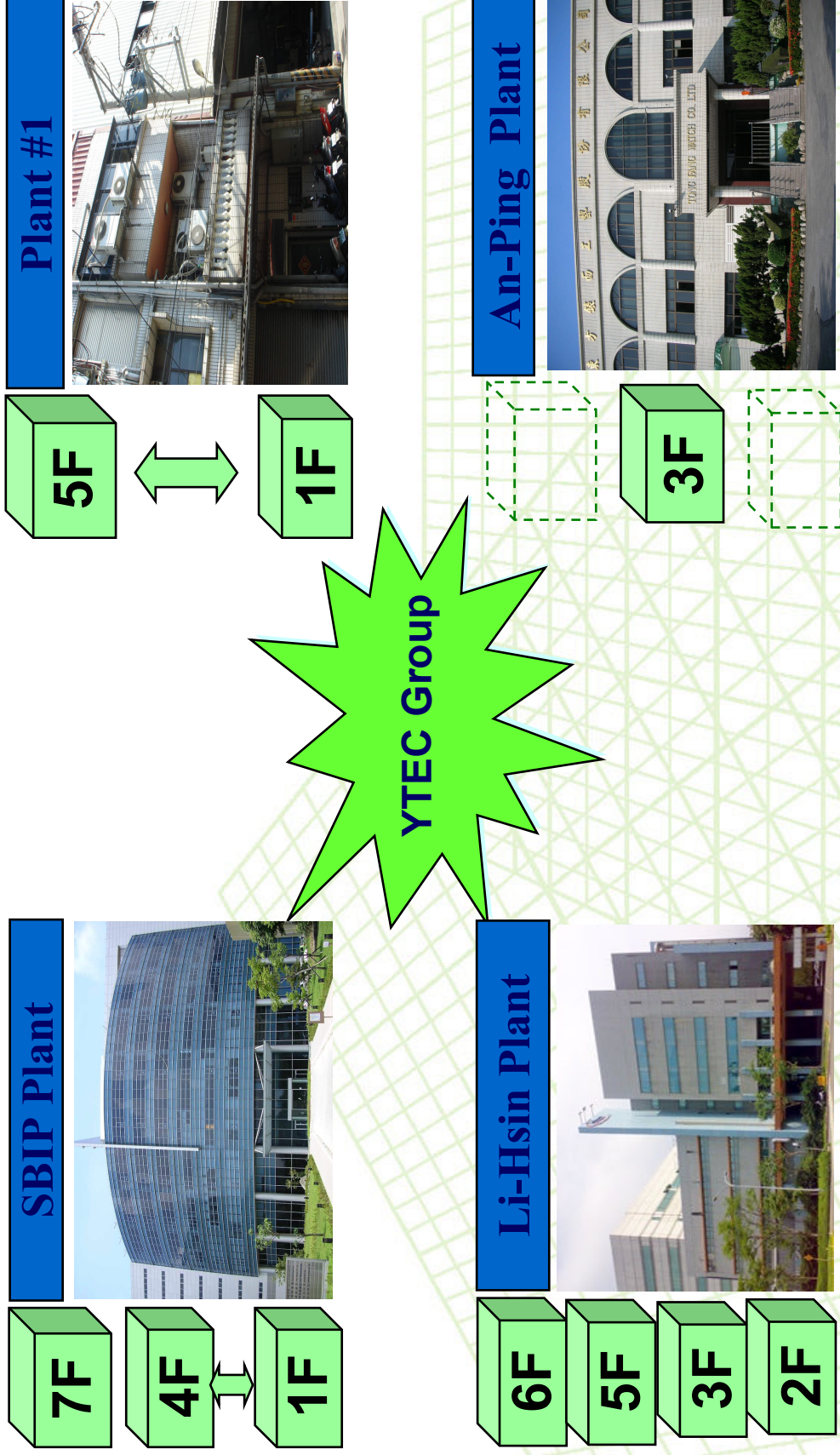

YoungTek Electronics Corp.



# Company Milestone

Company Profile

- 1991/Jul. YTEC was founded and the capital is NTD \$ 5 million.
- 1998/Oct. Develop logic tester (Goblin) with 5 MHz/40 pins.
- 2000/Mar. Achieved the certification of ISO 9001
- 2000/Jul. Full-function IC tester was verified by industry agency with predominant product development project.
- 2002/Nov. SEC (Securities and Exchange Commission) approve YTEC to public stock.
- 2003/Nov. LED OEM service was established.
- 2003/Dec. Obtain OTC certification.
- 2004/Mar. Got the approval to establish the branch in Hsin chu SBIP.
- 2004/Mar.29 Listed in Taiwan stock exchange. (Stock No.: 6261)
- 2006/Dec. Achieved the certification of ISO 14001 and OHSAS 18001.
- 2007/Jul. Develop Tainan An Ping plant for LED sorting.
- 2007/Nov. Build up AOI key technologies and business.
- 2008/May Develop Li Hsin plant for LED test & sorting.
- 2008/Otc. Achieved the certification of ISO/TS 16949.
- 2009/Jun. Solar silicon substrate inspection system was verified by Science Park Administration with development project.
- 2010/Mar. Develop SBIP plant for wafer grinding & sawing.
- 2011/Jan. Achieved the certification of IECQ QC080000.



**YTEC** YoungTek Electronics Corp.

# Company Management Concept

Company Profile

## 經營理念：(Management Concept)

主人翁經營理念；下工程即是客戶。

Treat YTEC as your own company. (Host concept)

Treat all post projects and processes as our customers.

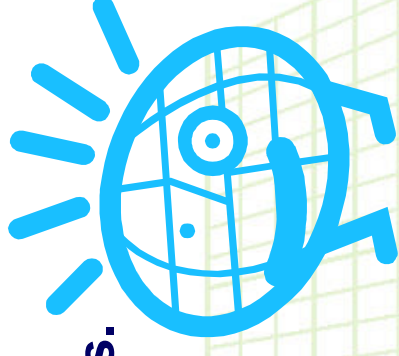

## 工作態度：(Working Attitude)

成功者找方法；失敗者找藉口。

**A successful person will find the way to overcome a challenge**

**Loser finds excuses.**



**YTEC** YoungTek Electronics Corp.





# 專業測試代工服務(IC Testing OEM)

## Company Profile

- ❑ 4"~12" Wafer testing (CP)、Test program and test kit development (Probe-card design and manufacture).
- ❑ IC packaging testing (FT)、Package type : DIPs、T/SOPs、L/QFPs、QFN、L/BGA...
- ❑ PC peripheral product、Logic、Analog、Mixed-signal、No-volatile memory、MCU、LCD driver IC、High speed/ High pin count (Scud-1A 512C) testing.
- ❑ CIS(CMOS Image Sensor)、RF、SoC product testing
- ❑ Others : Laser trimming、Lead scanning、Test program and test kit development technical support **Turn-key service** (For example: PKG assembly、Tape-reel、Drop-shipment...).

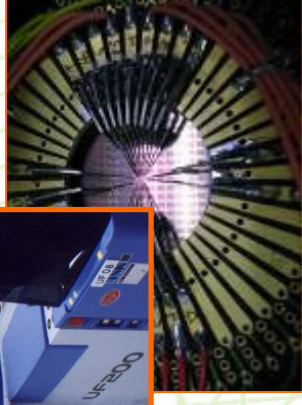
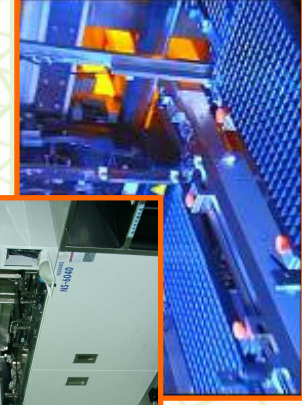
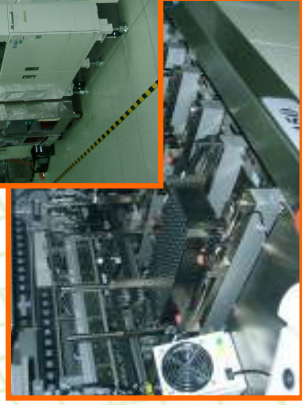
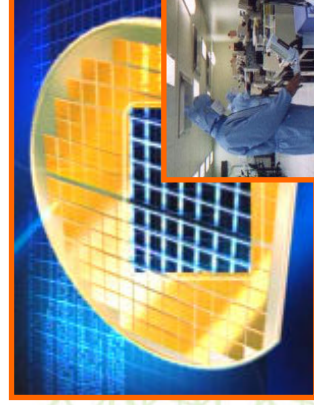
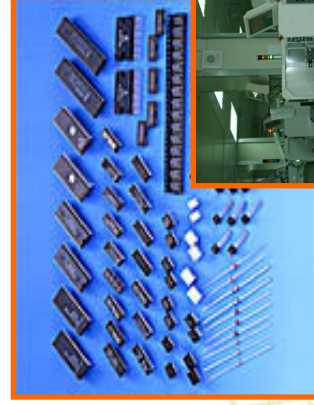



# 研磨、切割及挑檢代工服務 (Grinding, Sawing, P&P Service)

Company Profile

□ Service Items:

Wafer back-side grinding sawing chip pick & place services for Consumer and gold bump products.

Process	Back-side Grinding	Sawing	Pick & Place
Environment	 <p>Class 1K</p>	 <p>Class 1K</p>	 <p>Class 100</p>
Capability	<ul style="list-style-type: none"> <li>● 4"~12" Wafer</li> <li>● Back-side Grinding</li> <li>● 8"~12" Wafer</li> <li>● Polish Solution</li> <li>● Wafer TTV <math>\leq 5 \mu m</math></li> <li>● Chip TTV <math>\leq 2 \mu m</math></li> </ul>	<ul style="list-style-type: none"> <li>● 4"~12" Wafer Sawing</li> <li>● Dual Cutting Function</li> <li>● High-pressure &amp; Atomizing Cleaning System (二流體清洗裝置)</li> <li>● Dust Collecting System</li> </ul>	<ul style="list-style-type: none"> <li>● 4"~12" Wafer Pick &amp; Place</li> <li>● Map and Ink</li> <li>● Pick &amp; Place Solution</li> <li>● Chip Back-side AOI Inspection System</li> </ul>



YoungTek Electronics Corp.

# LED OEM Services

Company Profile

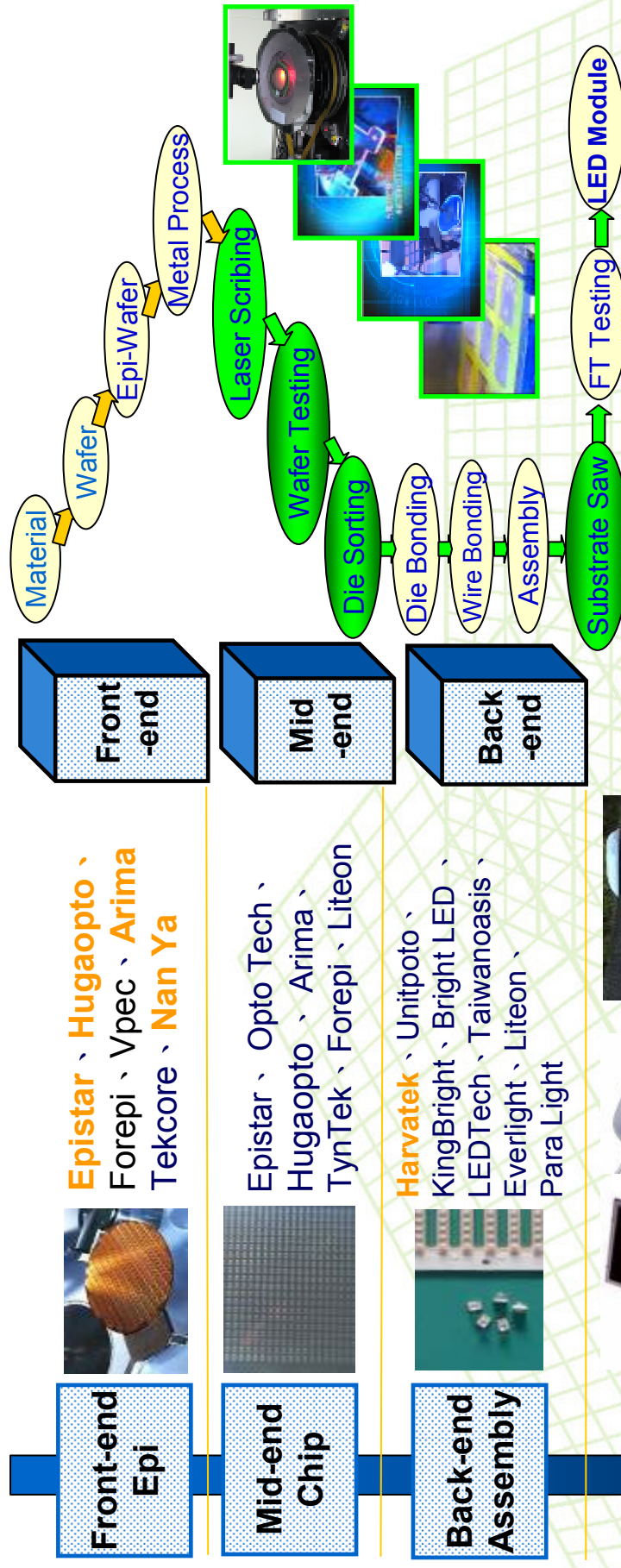

**YoungTek Electronics Corp.**





*Company Profile*

# Own Product Development



*YoungTek Electronics Corp.*

# Own Product Development

Company Profile

- YT5100 High Speed SOC IC Tester  
YT5100 全功能高速SOC IC測試機
- Scud-1A 512C full-function IC Tester  
Scud-1A 512C 全功能 IC 測試機
- CIS(CMOS Image Sensor System)  
CMOS影像感測系統
- HV LED Tester  
全功能 LED 測試機



YoungTek Electronics Corp.



# Own Product Development

Company Profile

## □CCM (CMOS/Compact Camera Module)

影像感測模組測試設備

## □AOI (Auto optical Inspection )

自動光學檢測系統

## □YT2500 Multi Station Dual Feeding LED Dispenser

YT2500 多站雙軌 LED 點膠機

## □YT6110 IC Test Handler

YT6110 IC 測試分類機



**YTEC** YoungTek Electronics Corp.

# YT5100&Scud-1A IC Tester

Company Profile

## YT5100 High Speed Soc IC Tester



## Scud-1A Fully Auto IC Tester





# Scud-1A IC Tester System Environment

Company Profile

The screenshots illustrate the following components of the Scud-1A IC Tester System Environment:

- TEST PROGRAM ZIP2:** A window for loading and configuring test programs, showing fields for PGM (e.g., 0501), PGM (e.g., 0501), and various test parameters.
- TEST PROGRAM:** A window displaying the test program code, including initialization, test setup, and test execution instructions.
- TEST RESULT:** A window showing a grid of test results, with colored cells indicating pass (green), fail (red), and other statuses.
- TEST LOG:** A window displaying detailed test results, including test item names, test results, and error messages.
- TEST SUMMARY:** A window displaying a summary of test results, including a table of test results and a summary of test statistics.

YoungTek Electronics Corp.



# CIS(CMOS Image Sensor) IC Tester

Company Profile

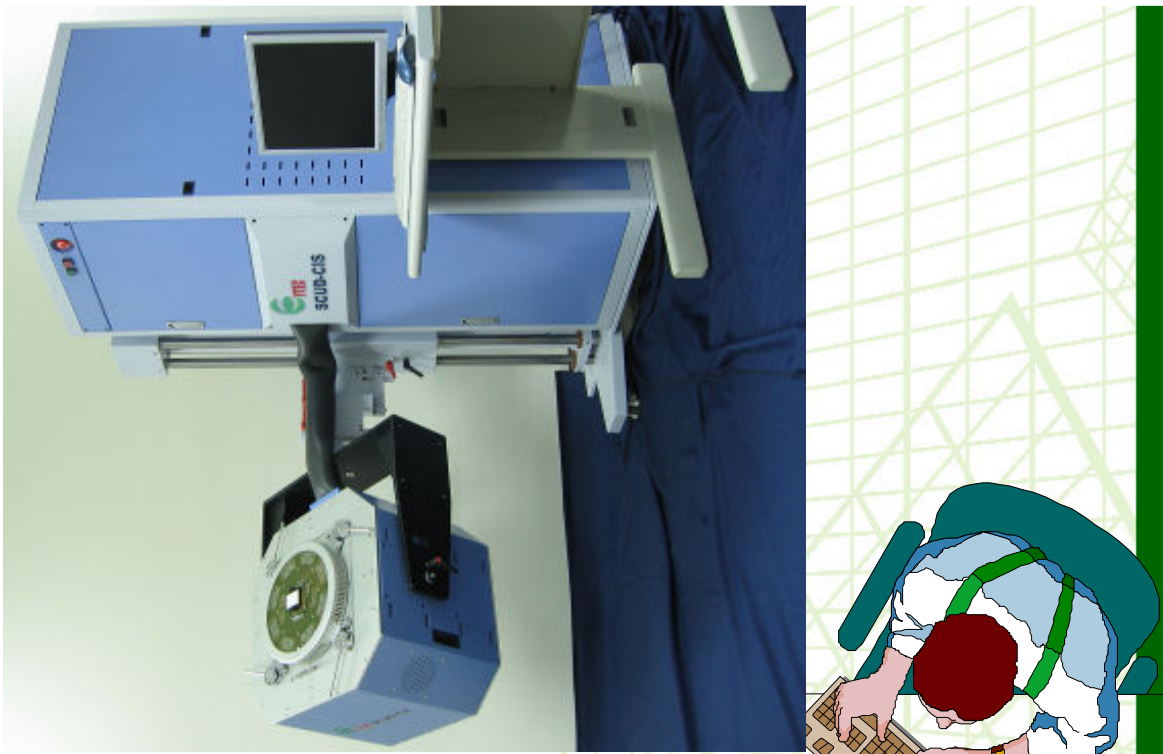
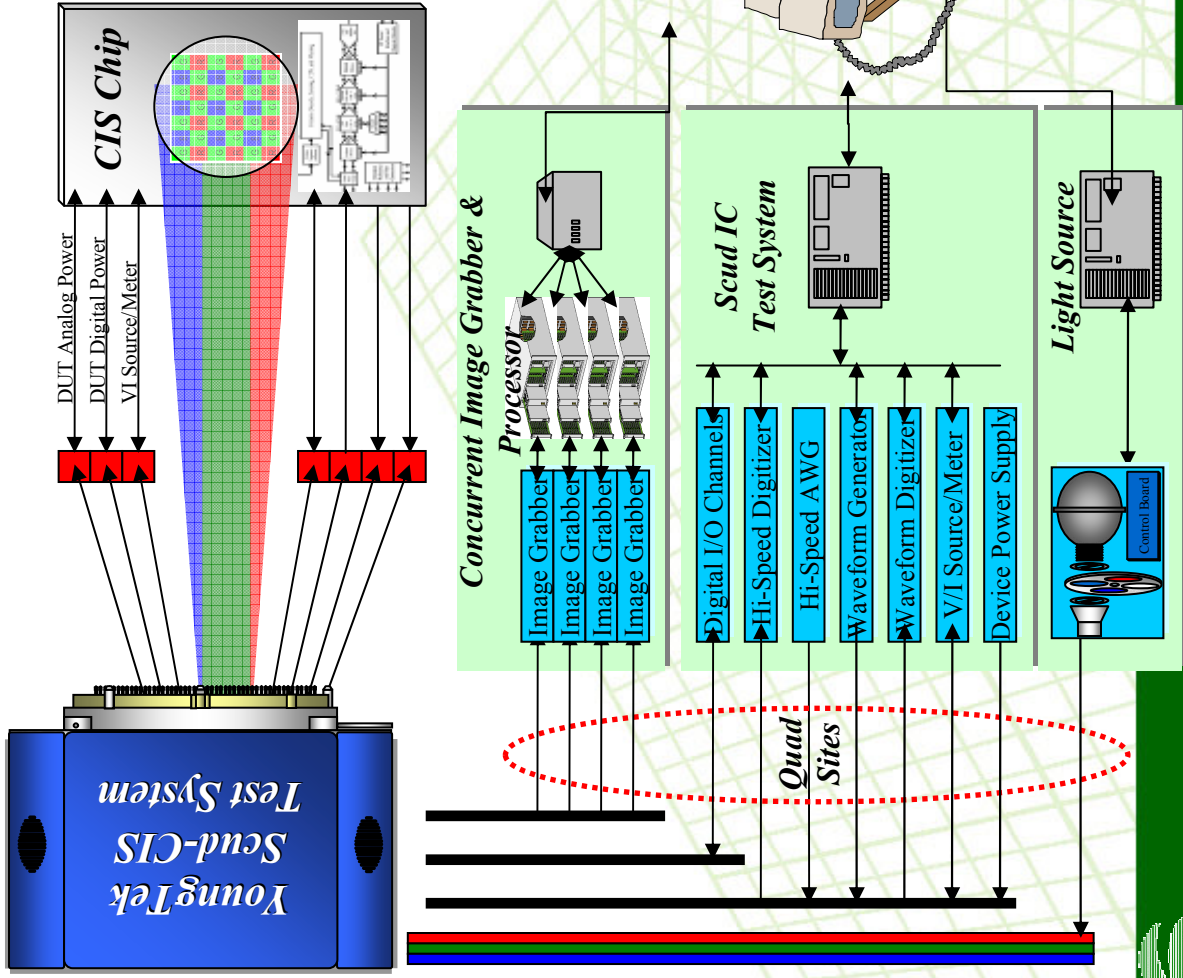



# YT1100 LED Tester(YT1100 LED 測試機)

Company Profile

- YTSD01 -> YTSD02 -> YT1000 HV LED Tester(8000V ESD)
- > YT1100 HV LED Tester (Multi-station)

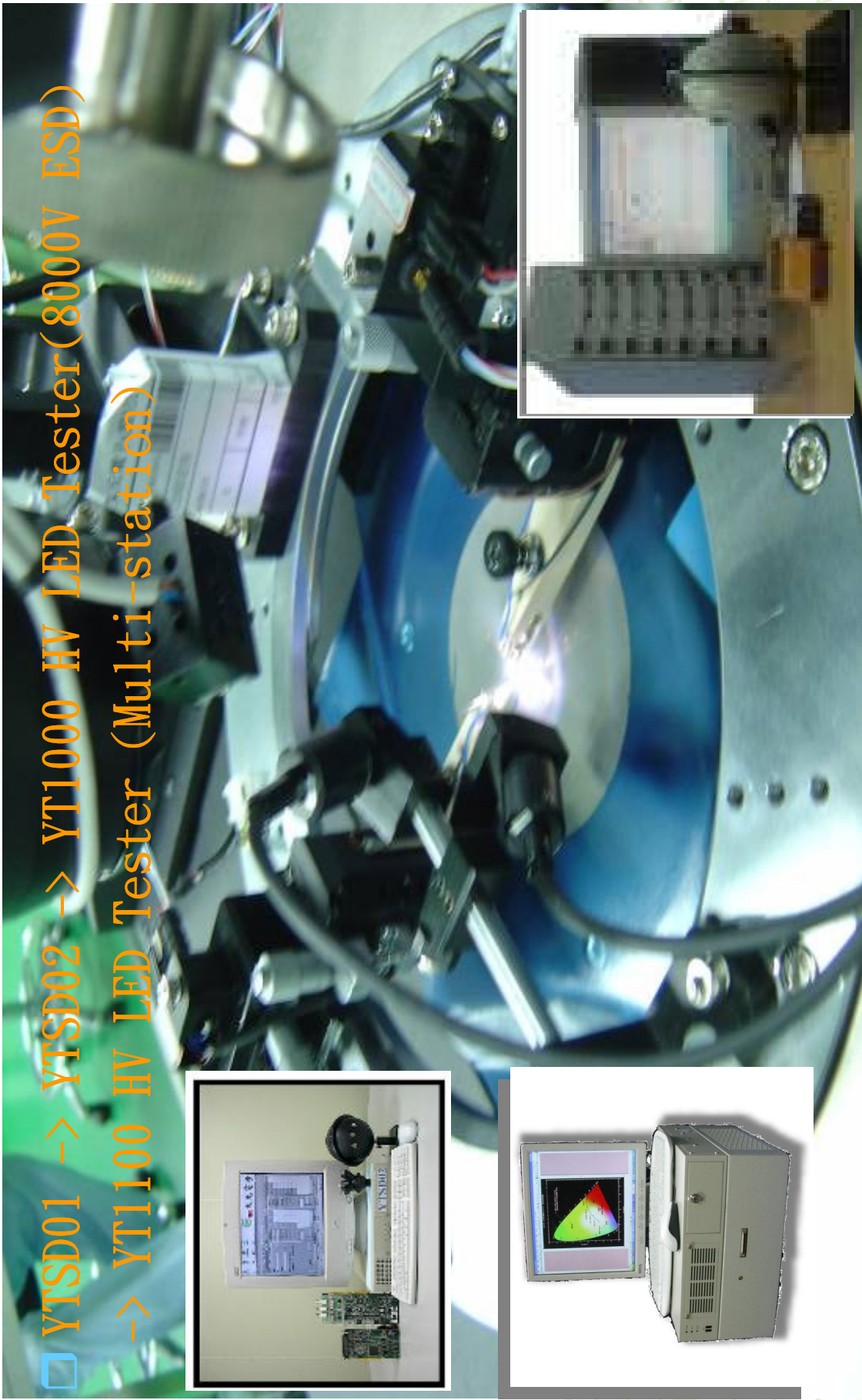

YoungTek Electronics Corp.

# CCM(CMOS/Compact Camera Module)

Company Profile

CCM Test System YT3100



Fully Auto CCM Test System YT3300

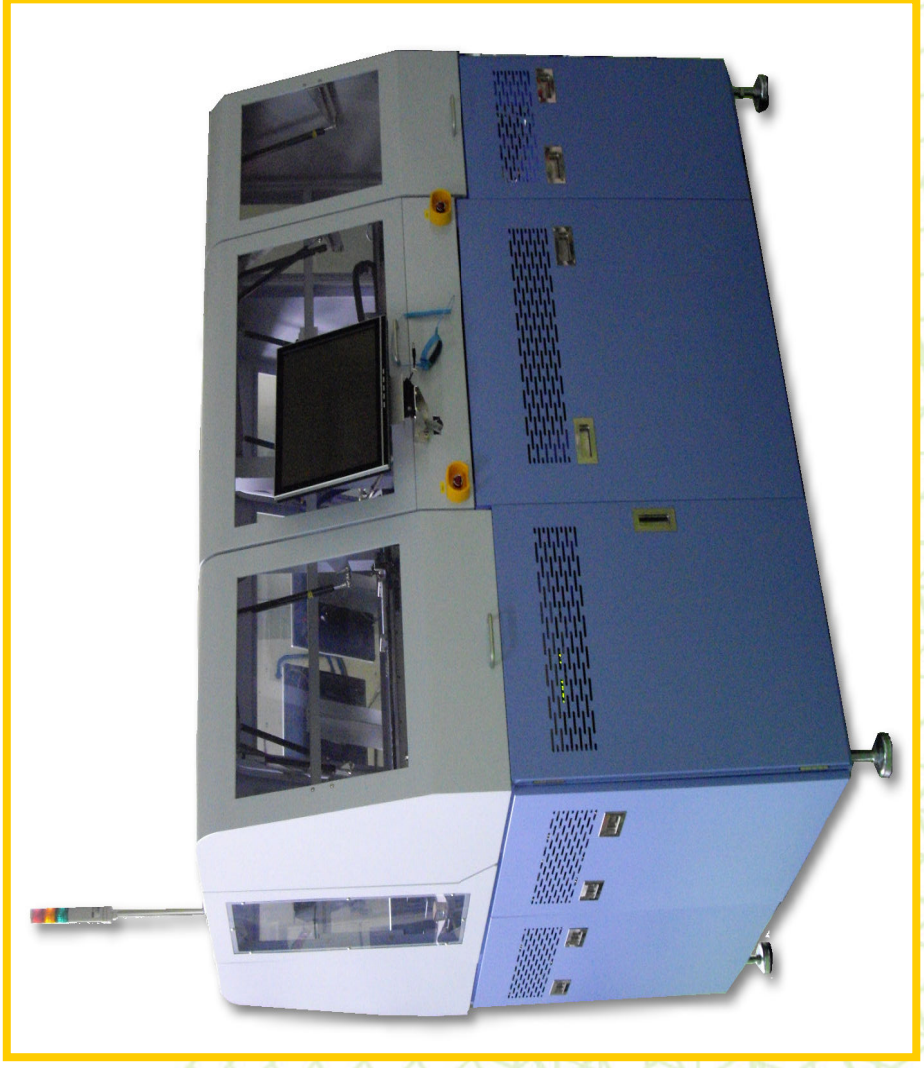



# Auto Optical Inspection (自動光學檢測系統)

Company Profile

**YT 5311 LED Chip/Wafer/Mask  
AOI System**

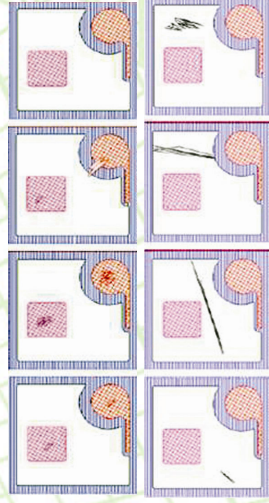

**YT 2800 LED Chip/Wafer/Mask  
AOI System**

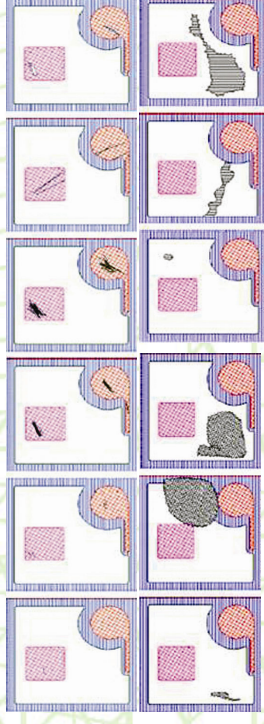

**YoungTek Electronics Corp.**

# Auto Optical Inspection (自動光學檢測系統)

Company Profile

## YT 2210 Reel Type Components AOI System

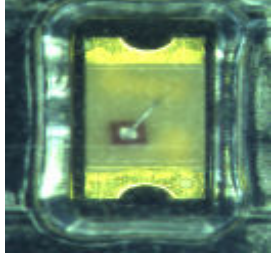

Polarity inverse package

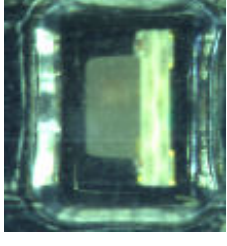

Tilt

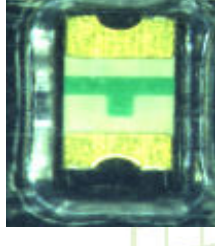

Over turn

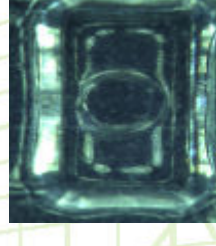

Empty

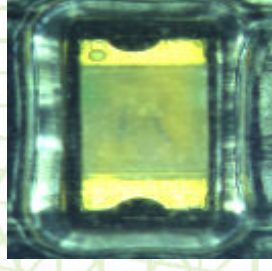

Mixed package



YTEC YoungTek Electronics Corp.



# Auto Optical Inspection Application

Company Profile

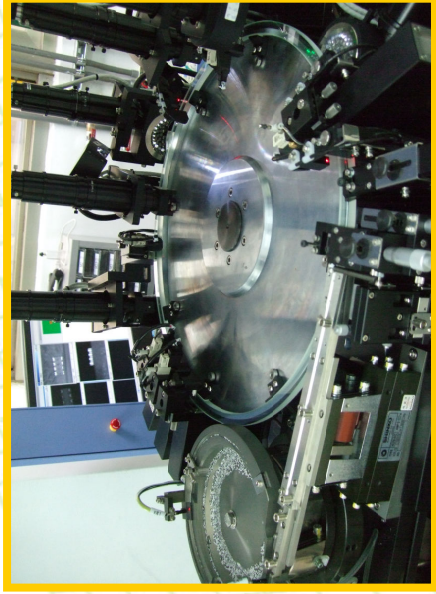
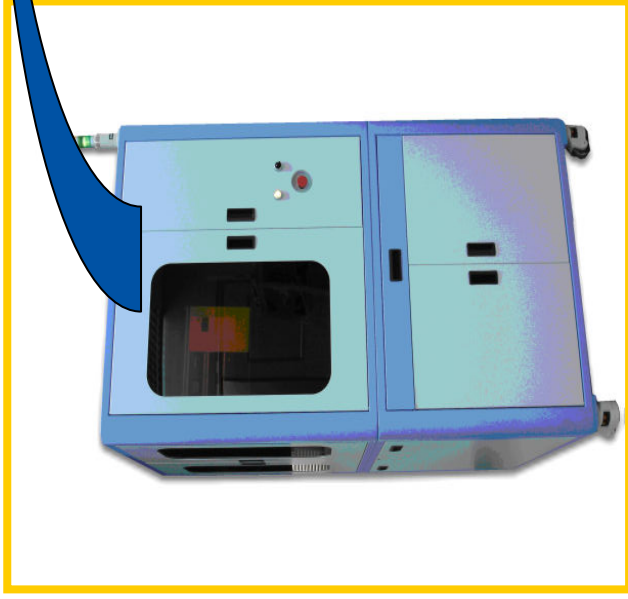

## Reel type taped products:

- Resistor
- Capacitor
- Inductor
- LED
- IC
- Relay
- Connector
- Fuse



YoungTek Electronics Corp.

# YT2500 LED Dispenser / YT6110 IC Test Handler

*Company Profile*

*YT2500 LED Dispenser*



*YT6110 IC Test Handler*







*Company Profile*

# Revenue Growth

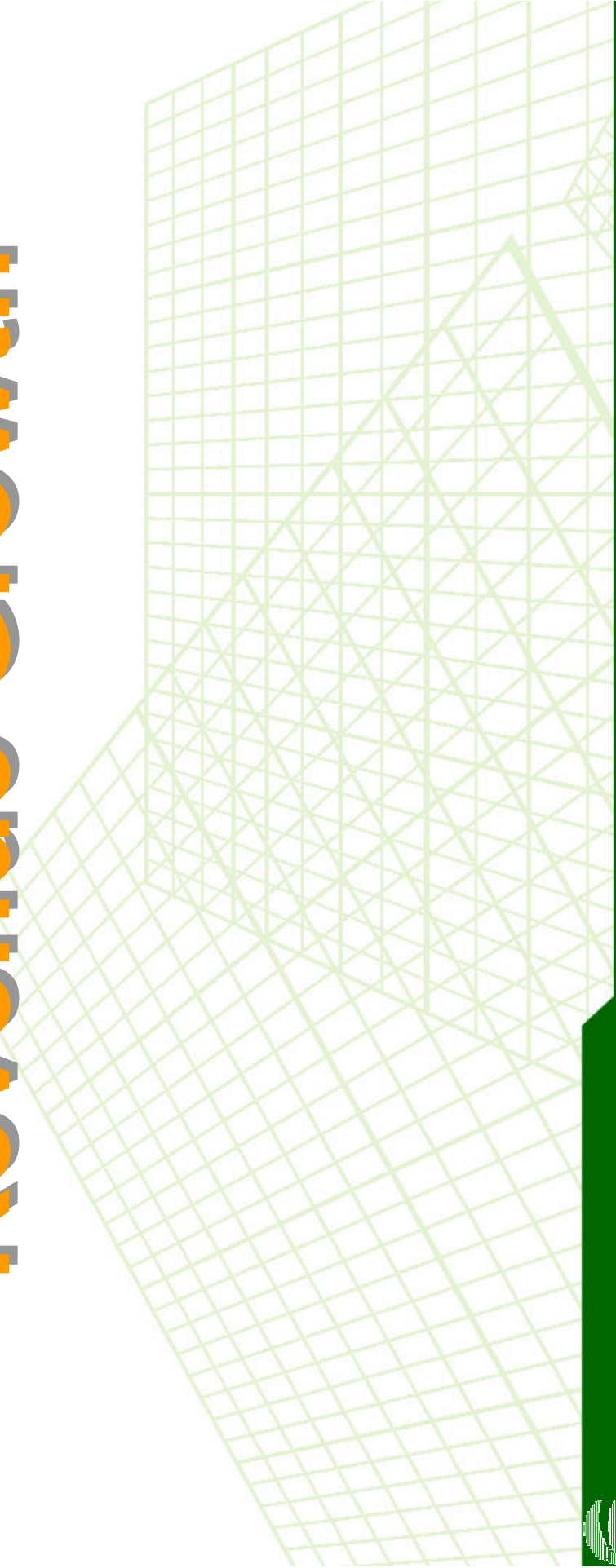

**YTEC** YoungTek Electronics Corp.

# 2011&2012 Monthly Revenue

Company Profile

NT\$(Thousand)

Business Item/Month	Jan.	Feb	Mar	Apr	May	Jun.	Jul.	Aug.	Sep	Oct.	Nov.	Dec.	Total	Share(%)
切割拋檢代工 Sawing & Sorting OEM	2011	107,086	131,677	124,662	130,566	128,825	127,673	103,794	98,761	94,537	89,523	81,498	99,641	47.51%
	2012												73,439	42.16%
	YoY	-26.30%												
	MoM	-9.89%												
測試代工 Testing OEM	2011	66,395	115,541	101,928	110,180	86,142	85,536	90,520	78,549	86,727	91,049	86,508	80,684	38.47%
	2012												95,751	54.97%
	YoY	18.67%												
	MoM	10.68%												
機器組裝等產品 銷售 Own Product Sales	2011	49,923	58,053	47,824	46,144	35,405	48,591	28,812	19,012	14,722	5,740	10,482	29,417	14.03%
	2012												5,011	2.88%
	YoY	-82.97%												
	MoM	-52.19%												
營業收入淨額 (Unit:K) Sales Revenue (Net)	2011	223,404	305,271	274,414	286,890	250,372	261,800	223,126	196,322	195,986	186,312	178,488	209,742	100.0%
	2012	0	0	0	0	0	0	0	0	0	0	0	174,201	100.0%
	YoY	-16.95%												
	MoM	-2.40%												
營業收入淨額 合計 Sales Revenue (Total)	2011	43,146	738,417	1,012,831	1,299,721	1,550,093	1,811,893	2,035,019	2,231,341	2,427,327	2,613,639	2,792,127	--	--
	2012													
	YoY	-16.95%												
	MoM													
總計代工成長 OEM Growth (Total)	2011	173,481	247,218	226,590	240,746	214,967	213,209	194,314	177,310	181,264	180,572	168,006	180,325	--
	2012												169,190	
	YoY	-6.17%												
	MoM	0.70%												



YoungTek Electronics Corp.



# 2002~2011 Revenue Growth

## Company Profile

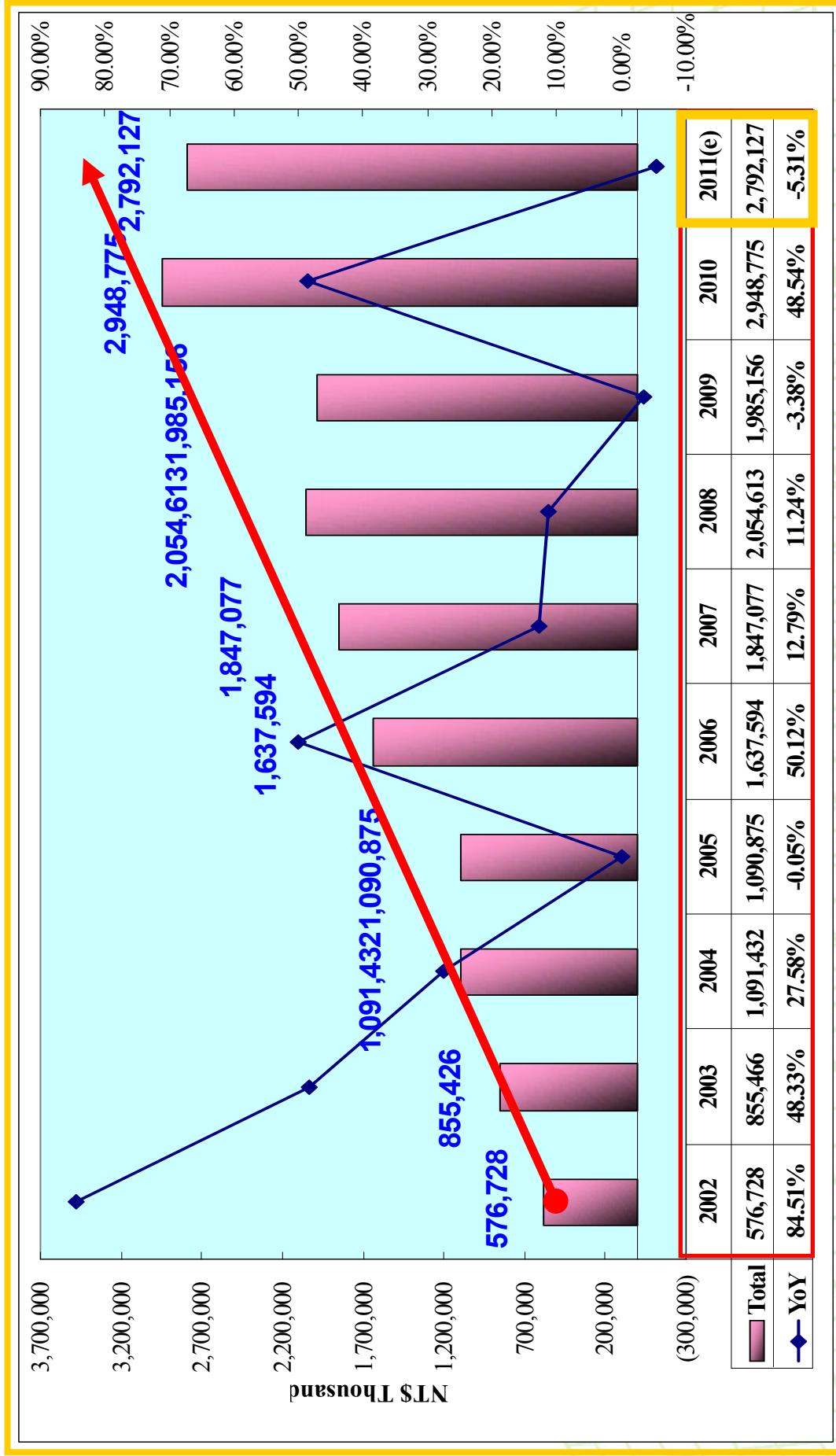

Note : (e)表示預估值(estimate)。

# 2010/2011 Gross Profit

## Company Profile

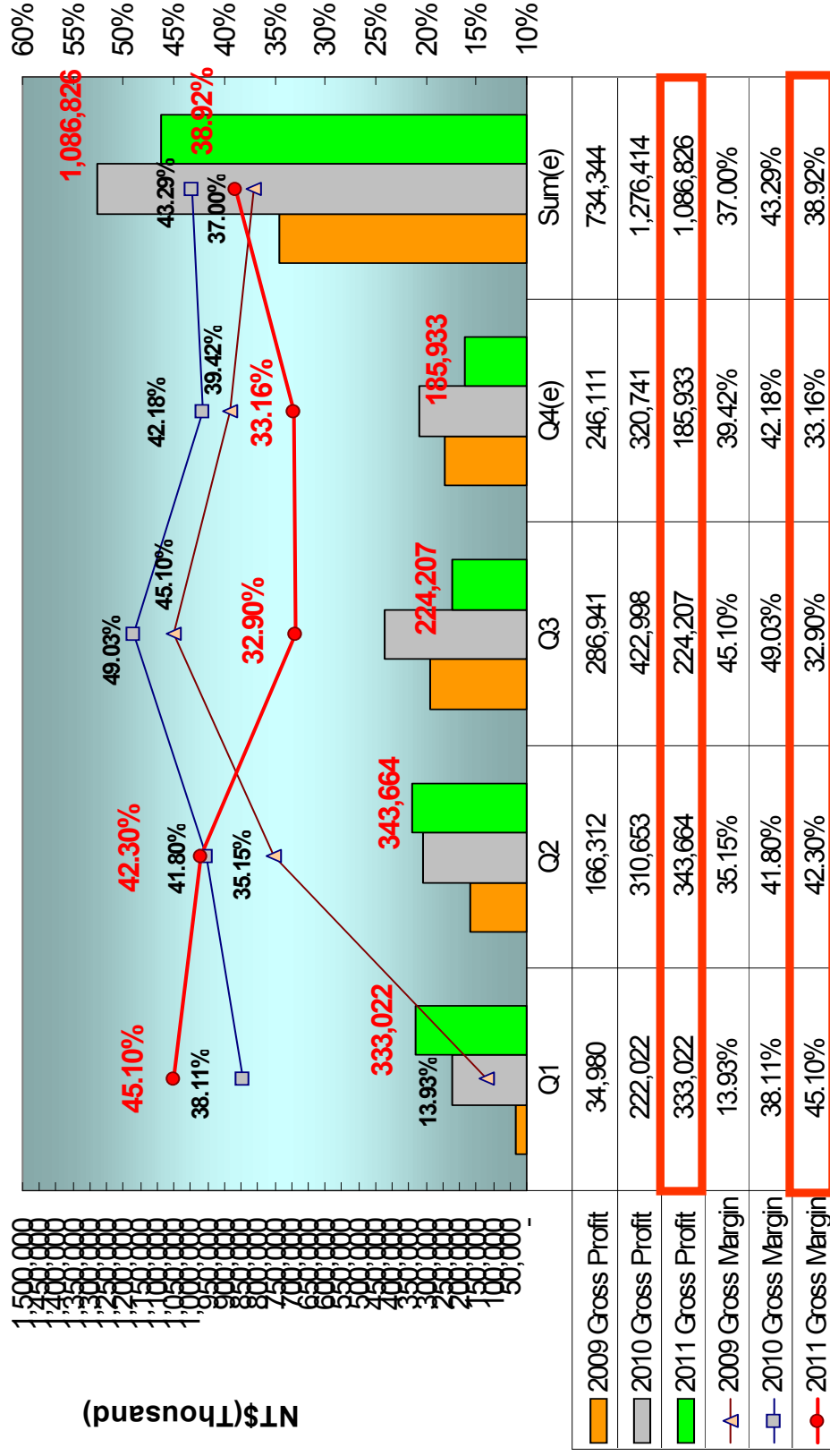

Note : (e)表示預估值(estimate)。



# Share payout composition and history

## Company Profile

Year	九十三年度 (2004)	九十四年度 (2005)	九十五年度 (2006)	九十六年度 (2007)	九十七年度 (2008)	九十八年度 (2009)	九十九年度 (2010)	100年度 (2011)
	九十二年 Profit(2003)	九十三年 Profit(2004)	九十四年 profit(2005)	九十五年 Profit(2006)	九十六年 Profit(2007)	九十七年 Profit(2008)	九十八年 Profit(2009)	九十九年 Profit(2010)
Cash(NID)	\$3.00	\$3.00	\$2.61	\$4.00	\$4.00	\$3.00	\$3.00	\$4.67
Free Pair stock	\$2.00	\$2.00	\$0.87	\$1.00	\$0.50	\$0.10	\$0.10	
Stoc k reserve fund	-	-	-	-	--	-	--	\$0.09
EPS(NID)	\$7.28	\$8.24	\$5.56	\$8.61	\$7.41	\$6.09	\$4.07	\$8.53



# 公司願景Company Mission

Company Profile

著眼於國內外市場的開拓，讓久元成爲立足台灣  
的整合性後段IC及LED代工服務廠，並朝放眼  
世界的自有產品、自有品牌邁進。

Based on the domestic and international marketing development, YTEC has gotten a foothold as an integrated back-end IC&LED OEM factory. YTEC moves forward, with it's own products, and Own Bench Marks.

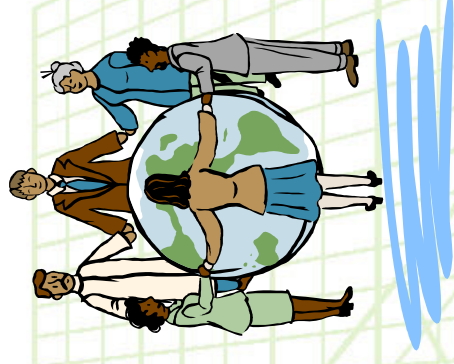

**YTEC** YoungTek Electronics Corp.



Q & A

Company Profile

Thank you very much



YoungTek Electronics Corp.